

## COTELL OFFICES WORLDWIDE

### HEADQUARTER

**Cotell International Limited**  
10F,Block A3,Lilang Software Park, NO31,  
Bulan Road,Longgang District,Shenzhen  
Tel : +86 755 8885 9898  
Fax : +86 755 8885 9899  
Email:sales@cotell.cn  
www.cotell-international.com



## CONNECTIVITY PANEL

Cotell® is the leading international brand for Guestroom Telephones, connectivity Devices , Electrical Faceplates and Integrated Smart Guestroom Management Systems. Since its founding in 2004, Cotell's commitment to design excellence, functional superiority and technical innovation has made it the brand of choice for the world's most discerning and demanding hoteliers. Cotell continues to evolve with a loyalty to preserving its heritage while moving forward with a modern, creative approach, elevating its standards to exclusivity while maintaining its competitive cost structure. The RUPTURA Series Advance Connectivity Panels represent the forward thinking manner of the brand.

Utilizing the finest craftsmanship, skilled production and ingenuity, The RUPTURA Series Advance Connectivity Panels can be configured to achieve the highest levels of aesthetic design. An exceptionally wide choice of materials, colors and finishes is available for harmonization with any architectural design concept and interior décor. Combining outstanding performance and durability, Cotell® embodies premium quality and design for the next generation hospitality industry.

**COTELL**®

## Selectable Functional Module

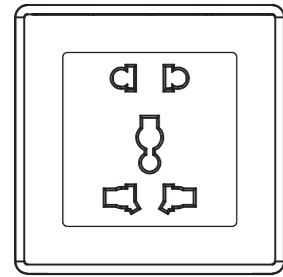

INTERNATIONAL POWER  
+ EURO POWER

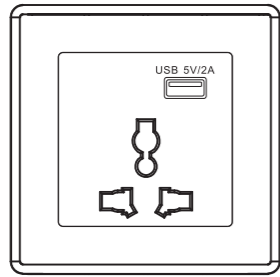

INTERNATIONAL POWER  
+ 5V / 2.1A / USB CHARGER

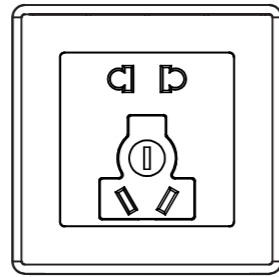

CHINA POWER  
+ EURO POWER

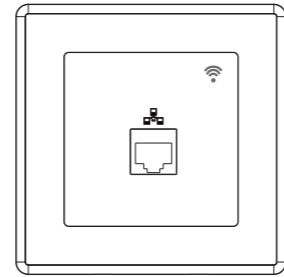

WIFI + DATA

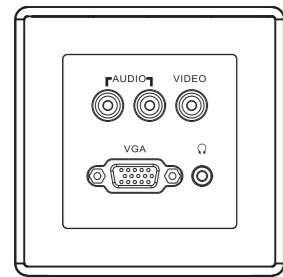

AUDIO / VIDEO + VGA  
+ 3.5MM AUDIO

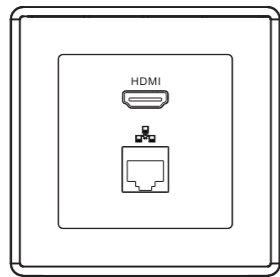

HDMI + DATA

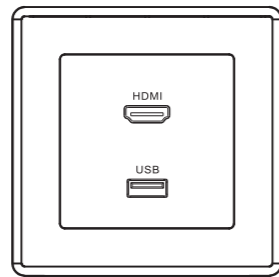

HDMI + USB

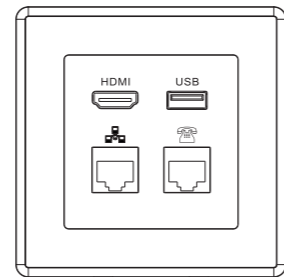

HDMI + USB + DATA + TEL

## COLOR & MATERIAL OPTION



## CONFIGURATION



## STANDARD 86 BASE BOX





OPTION & CHOICE





OPTION & CHOICE

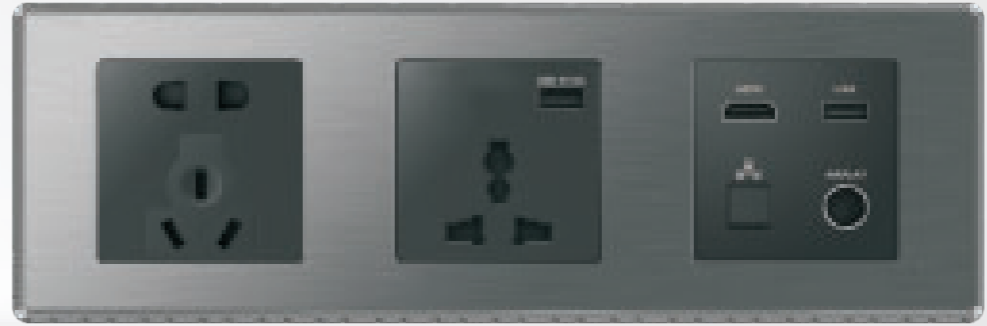



## OPTION & CHOICE





## EXPLODED VIEW

ControlCom™ elevates the standards of guestroom detailing, refined aesthetics and technical innovation to the highest level with the Advance Connectivity Panels.

Manufactured to the highest quality using the latest manufacturing technique, The Advance Connectivity Panels will enhance the guestroom appearance and exclusive outlook, a prerequisite expected by the hotel and demanded by the interior designer.

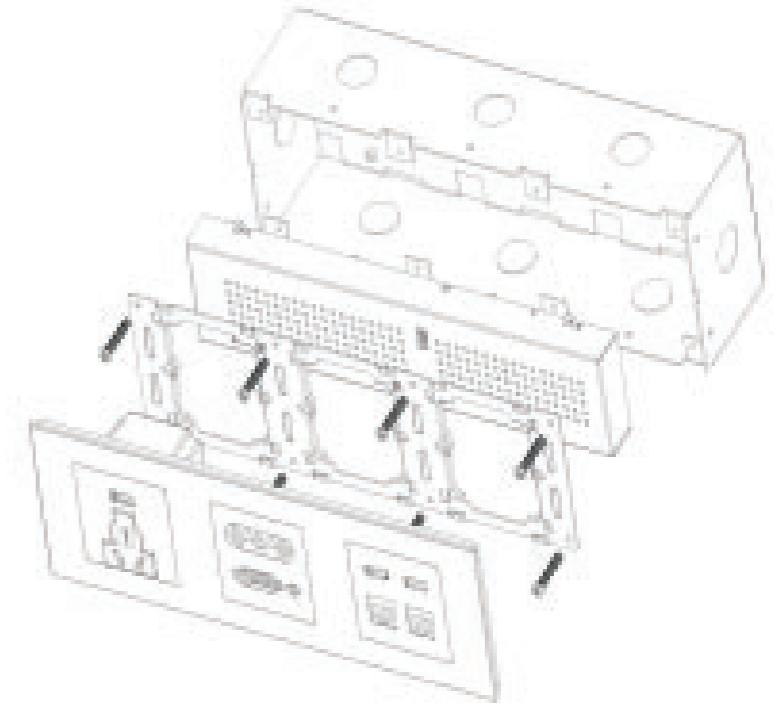



## HIGHLIGHT

- Material & Color option
- Uses Standard 86 base box
- Horizontal or Vertical Mount
- Selectable functional module
- International Power +5V/2.1A/USB Charger
- Wi-Fi +RJ45 DATA Module

## How to Decide the Configuration

### Step 1:

Decide the number of gang required for the faceplate

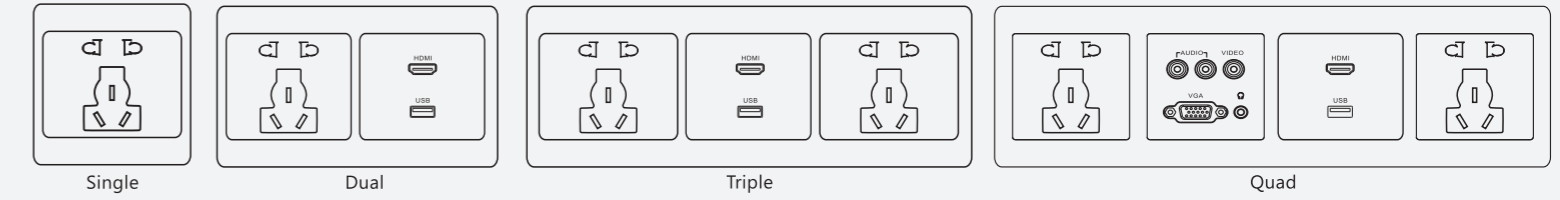

### Step 2:

Decide the faceplate material & colour



### Step 3:

Decide the functional module/combination of modules

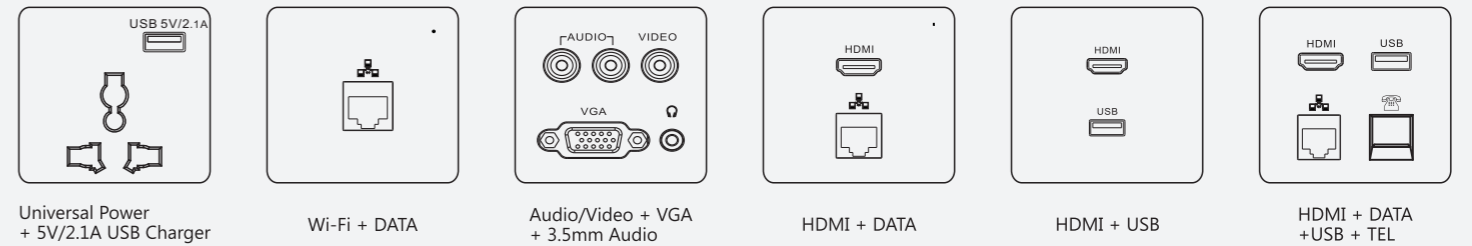

## Message from President & CEO

---

ONLY THROUGH CREATIVE DESIGN, INSPIRATION,  
AND TRUE INNOVATION CAN  
TECHNOLOGY REALLY ENHANCE THE HOTEL GUEST EXPERIENCE.  
THIS IS WHAT DRIVES OUR BUSINESS

Wang Swee Lee  
President & CEO  
Cotell International Limited

## Our Commitment

Cotell is committed to deliver innovative state-of-the-art guestroom communication and energy management Solutions to the hoteliers all over the world. With our team expertise and accumulated global experience, We are able to set the standard in hospitality in-room technology. We create lead in innovation to ensure the hoteliers are at the forefront of technology. We ensure your hotel maintain world-class status while we care for your service optimization, process efficiency, Guest loyalty and profitability.